

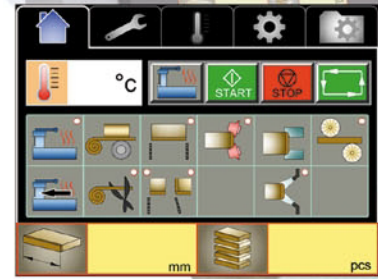

# AUTOMATIC EDGE BANDER

## The control system-quality and precision by 5.6" Color Touch screen

- High operating convenience through simple menu format and optimized touch screen adjustment
- Fast access to all unit function through
- Easy to change the glue unit temperature depends on glue material different
- Clear error message display
- 8 languages included
- Display the total amount of working quantity and total amount working length



ITEM	MODEL	UNIT	FirmMax 2-2	FirmMax 2-3	FirmMax 3-2	FirmMax 3-3	FirmMax 4-2	FirmMax 4-3
Max. panel thickness		mm	8~40	8~40	8~40	8~40	8~40	8~40
Max. thickness edges in rolls		mm	0.2~2	0.2~3	0.2~2	0.2~3	0.2~2	0.2~3
Min. panel width		mm	60	60	60	60	60	60
Min. panel length		mm	100	100	100	100	100	100
Air pressure in working conditions		bar	6	6	6	6	6	6
Heating time		min	5~6	5~6	5~6	5~6	5~6	5~6
Capacity of glue pot		Lt	2	2	2	2	2	2
Feeding speed		m/min	10	10	10	10	10	10
Diameter dust extraction hoods		mm	76	76	76	76	76 and 100	76 and 100
Noise level		db	72~76	72~76	72~76	72~76	72~76	72~76
Machine Length		mm	2400	2400	2700	2700	2955	2955
Machine Width		mm	725	725	725	725	725	725
Machine Height		mm	1400	1400	1400	1400	1400	1400
Machine Weight		kgs	550	550	610	610	690	690

MODEL	Gluing unit	Edge cut device	Pressure unit	End trimming unit	Edge trimming unit	Scraper unit	Glue scraper unit	Buffing unit
FirmMax 2-2/2-3	●	●	●	●	●			
FirmMax 3-2/3-3	●	●	●	●	●	*	*	*
FirmMax 4-2/4-3	●	●	●	●	●	*	*	●

● Standard \* Optional



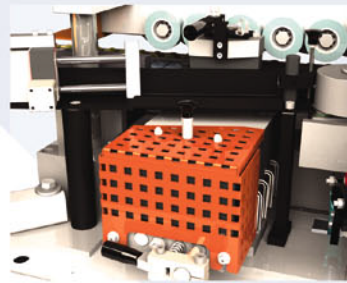

■ Capacity of glue pot is 2 Lt

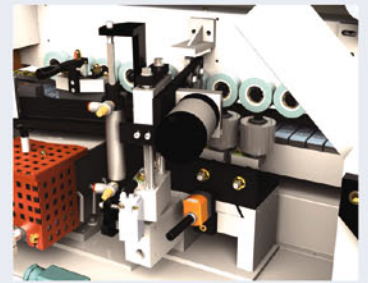

■ Pressure unit and edge cut device

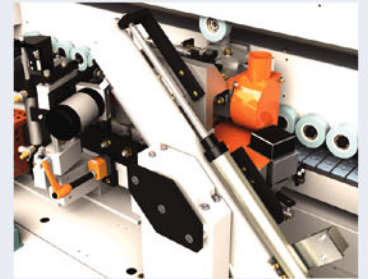

■ HF motor 12000 rpm / 0.3 kw / 200 Hz on twin blade of the end Trimming unit Twin blade tilting fixed at 0° and 15°

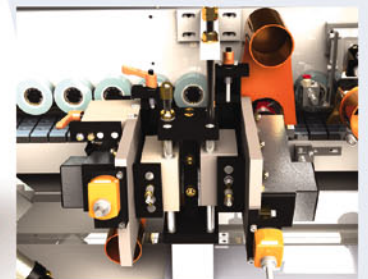

■ HF motor 12000 rpm / 0.3 kw / 200 Hz for up and down edge trimming unit

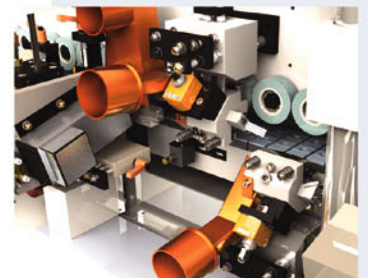

■ Scraper unit



■ Buffing unit with motor on 1/4HP (0.18kw) for edge cleaning

## FirmMax 4-2 AUTOMATIC EDGE BANDER

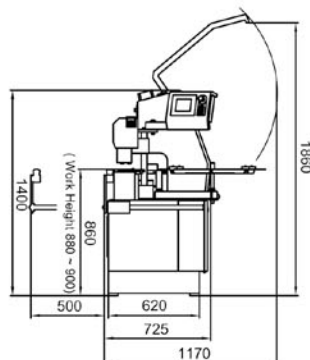
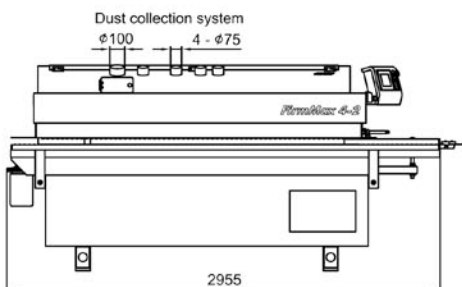
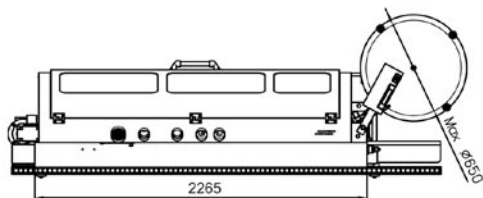

**JOWAY**

**JO-WAY MACHINERY CO., LTD.**

No. 159, Ta Ming Rd., Shen Kang Dist., Taichung 429, Taiwan.

TEL : 886-4-2526-6859

FAX: 886-4-2525-2890

Http: //www.jo-way.com

E-mail: joway@jo-way.com